

PODSTAWY DO STOŁÓW
TABLE BASES
TISCHGESTELLE



2011/2012

Szanowni Państwo,

Przedstawiamy Państwu polską kolekcję podstaw do stołów, przeznaczoną do wyposażania obiektów użyteczności publicznej, takich jak: restauracje, bary i kawiarnie.

Tworząc ją, staraliśmy się uwzględnić potrzeby każdego odbiorcy, zarówno pod względem przeznaczenia, stylistyki, jak również parametrów technicznych.

Mamy w kolekcji podstawy nowoczesne wykonane w stali nierdzewnej i lakierowanej oraz klasyczne i stylizowane, wykonane w litej drewnie bukowym i żeliwie.

Większość proponowanych wzorów zaprojektowano w naszym biurze projektowym.

Jesteśmy otwarci na wszelkie twórcze uwagi, które pomogą nam w udoskonalaniu oferty, a Państwu przyniosą więcej zadowolenia ze współpracy z nami.

Serdecznie zapraszamy do podjęcia współpracy.

Dear Sirs,

We have pleasure to present the polish collection of table bases, designed for equipment of public utility like restaurants, bars, cafe etc.

Creating our products we have been trying to regard needs of potential clients in the matter of using and stylistic as well as technical parameters.

In our collection You may find modern bases made of stainless or varnished steel and classical bases made of cast iron and solid beech wood.

Most of our models were designed in our project office.

We are open for any comments, which can help us to improve the offer and can bring You satisfaction from the collaboration.

We kindly invite You for the cooperation!

Sehr geehrte Damen und Herren,

Wir wollen Ihnen unsere Kollektion der Tischunterbauten mit der Bestimmung für Objekte der Gemeinnützigkeit, wie: Restaurant, Bar, Imbissstuben und Cafe anbieten.

Bei der Entwicklung der Kollektion waren wir bemüht, Bedürfnisse jedes Abnehmers sowohl in Hinsicht auf die bestimmungsgemäße Verwendung und Gestaltung als auch auf technische Parameter zu beachten.

In unserer Kollektion besitzen wir moderne Unterbauten aus Edelstahl bzw. lackiertem Stahl sowie klassische und stilisierte Unterbauten, hergestellt aus massivem Buchenholz und Gusseisen.

Angebotene Muster wurden größtenteils in unserem Projektbüro geplant.

Wir sind absolut offen für sämtliche schöpferische Bemerkungen, die unser Angebot verbessern und Ihnen Zufriedenheit mit der Zusammenarbeit mit uns bringen können.

Wir laden Sie herzlich zur Zusammenarbeit ein.

baza żeliwna + kolumna z drewna bukowego
 cast iron base + wooden column (beech)
 Gusseisenbasis + Buchenholzstütze

PODSTAWY ŻELIWNO-DREWNIANE

CAST IRON + WOOD
 GUSSEISEN- UND HOLZUNTERBAU



ZL C 06

I	I	I	kg
620 x 420	720	1200 x 800	26.5

ZL B 02 COFFEE



kg
18.0

ZL B 04 COFFEE



I	I	I	kg
430 x 430	600	800 x 800	17.5

ZL B 02 BAR



I	I	I	kg
430 x 430	1060	700 x 700	19.0

ZL C 04*



I	I	I	kg
620 x 420	720	1200 x 800	25.0

ZL C 04 COFFEE



I	I	I	kg
620 x 420	600	1200 x 800	24.5

ZL C 04 BAR



I	I	I	kg
620x420	1060	1100 x 700	26.5

ZL B 02*



I	I	I	kg
430 x 430	720	800 x 800	18.5

* model dostępny w wysokości COFFEE i BAR
 model is available in COFFEE and BAR height / Modell verfügbar in der Höhe COFFEE und BAR

NIEZAWODNOŚĆ

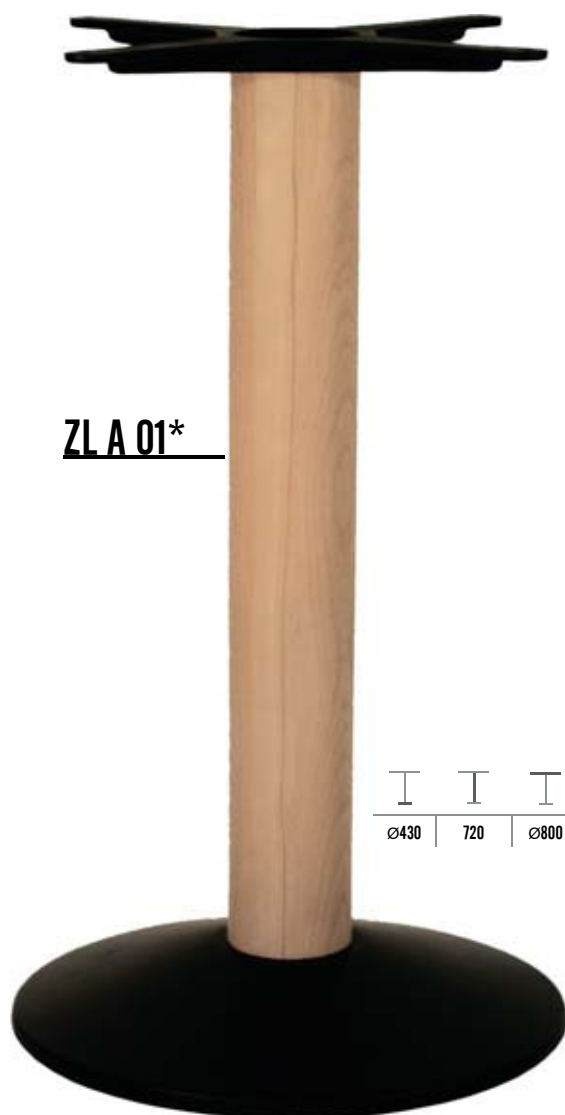

ZLA 01*

720	Ø430	Ø800	17.5 kg

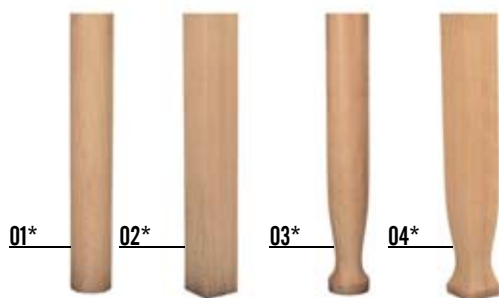

01*

02*

03*

04*



05

06

07

11*

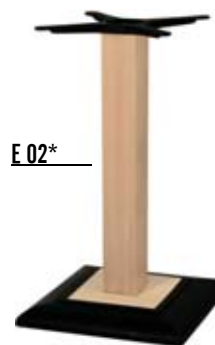

E 02*

420 x 420	720	800 x 800	18.5 kg



ZLA 03 COFFEE



ZLA 01 COFFEE

17.0	Ø430	600	Ø800	16.5 kg

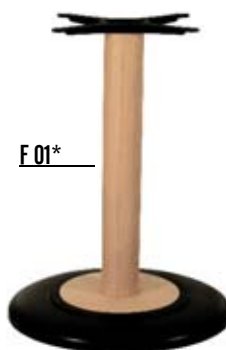

F 01*

25.5	Ø550	720	Ø1100



F 03 BAR

27.0	Ø550	1060	Ø900



D 05

18.0	Ø420	720	Ø800

cast iron base + wooden column (beech)

Gusseisenbasis + Buchenholzstütze

CAST IRON + WOOD

GUSSEISEN- UND HOLZUNTERBAU



GH 02*

710 x 710	720	∅1100 1000 x 1000	22.0

GH 02 COFFEE

710 x 710	600	∅1100 1000 x 1000	21.5

GH 02 BAR

710 x 710	1060	∅900 800 x 800	24.0

E DUET 04 BAR



740 x 480	1060	1200 x 700	42.0

E DUET 02*



740 x 480	720	1400 x 900	40.5

HH 04*

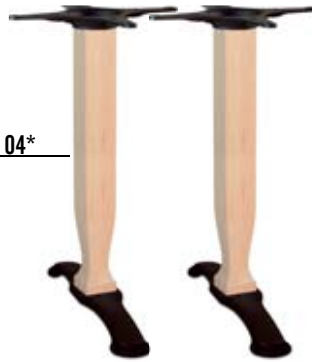

710	720	1600 x 900	25.5

BIS W 4R



450 x 450	720	800 x 800	17.5

BIS W 3R



550	720	∅800	15.5

NATURA

* model dostępny w wysokości COFFEE i BAR
 model is available in COFFEE and BAR height / Modell verfügbar in der Höhe COFFEE und BAR



GH 10*

710 x 710	720	Ø1100 1000 x 1000	21.5 kg



STAR BASE 10

350 x 350	720	700 x 700	17.0 kg

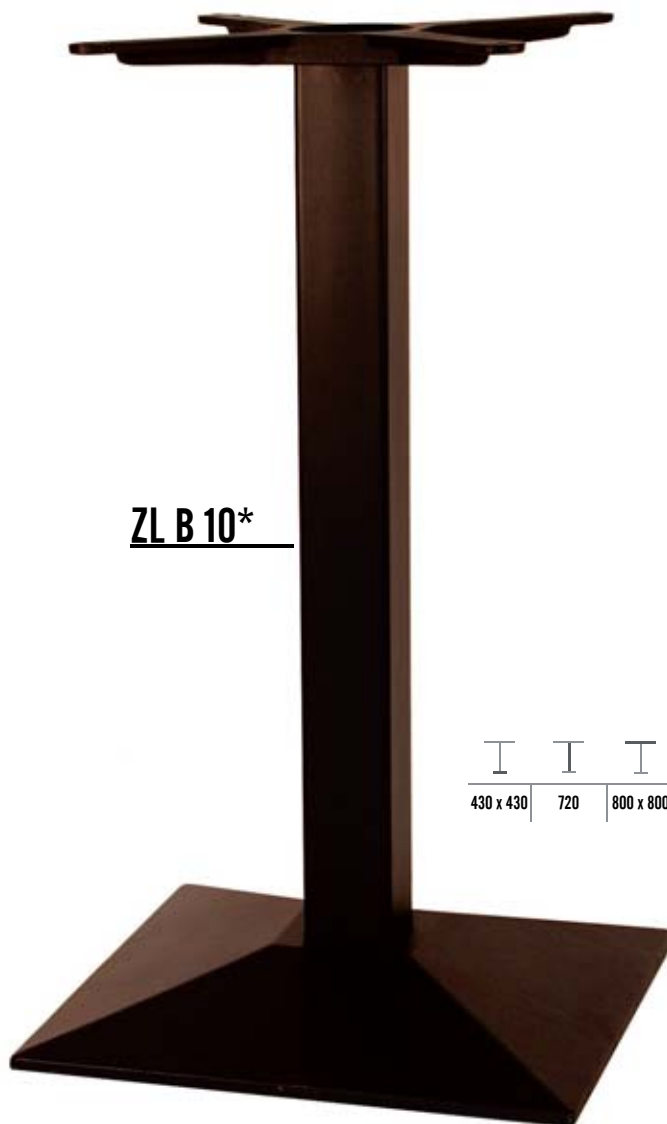

ZL B 10*

430 x 430	720	800 x 800	18.0 kg



L 10*

430 x 430	720	800 x 800	18.0 kg



L BIG 10*

560 x 560	720	1000 x 1000	28.0 kg



HH 10*

710	720	1600 x 900	25.5 kg



ZL C 10*

620 x 420	720	1200 x 800	25.0 kg

cast iron base + steel column black

Gusseisenbasis + Stahlstütze, Farbe schwarz

CAST IRON + STEEL

GUSSEISEN- UND STAHLUNTERBAU

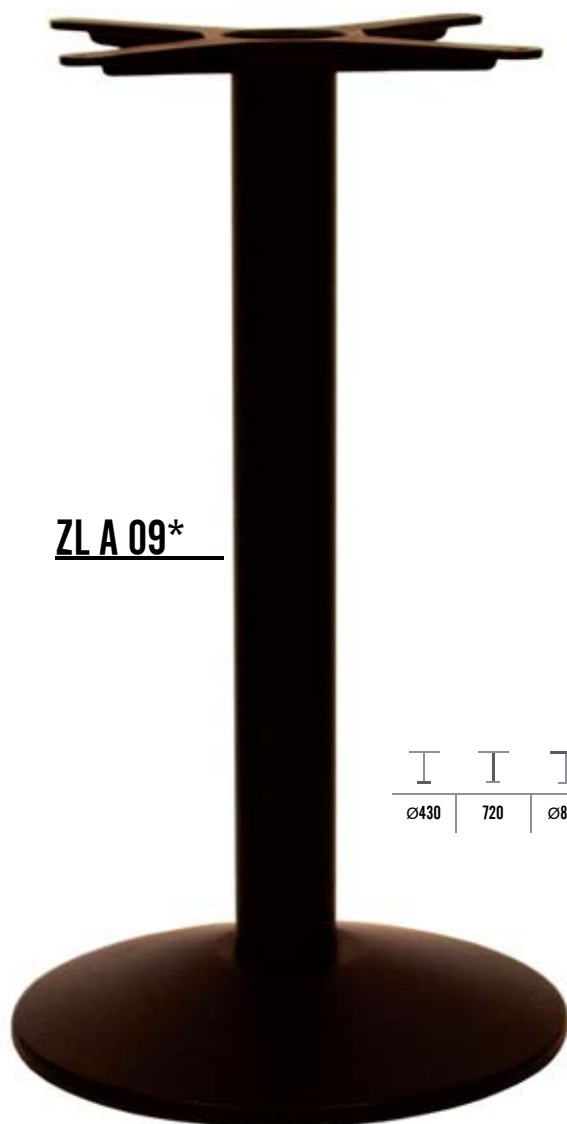

ZL A 09*

∅430	720	∅800	17.0

ZL A 09 COFFEE



∅430	600	∅800	16.0

ZL A 09 BAR



∅430	1060	∅700	18.5



GH 09*

710 x 710	720	∅1100 1000 x 1000	21.5



HH 09*

710	720	1600 x 900	25.5

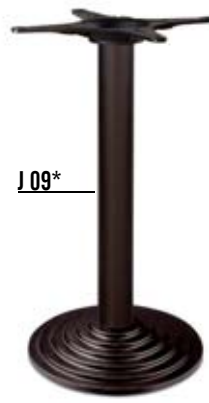

J 09*

∅430	720	∅800	17.5



J BIG 09*

∅560	720	∅1100	20.0

* model dostępny w wysokości COFFEE i BAR
model is available in COFFEE and BAR height / Modell verfügbar in der Höhe COFFEE und BAR

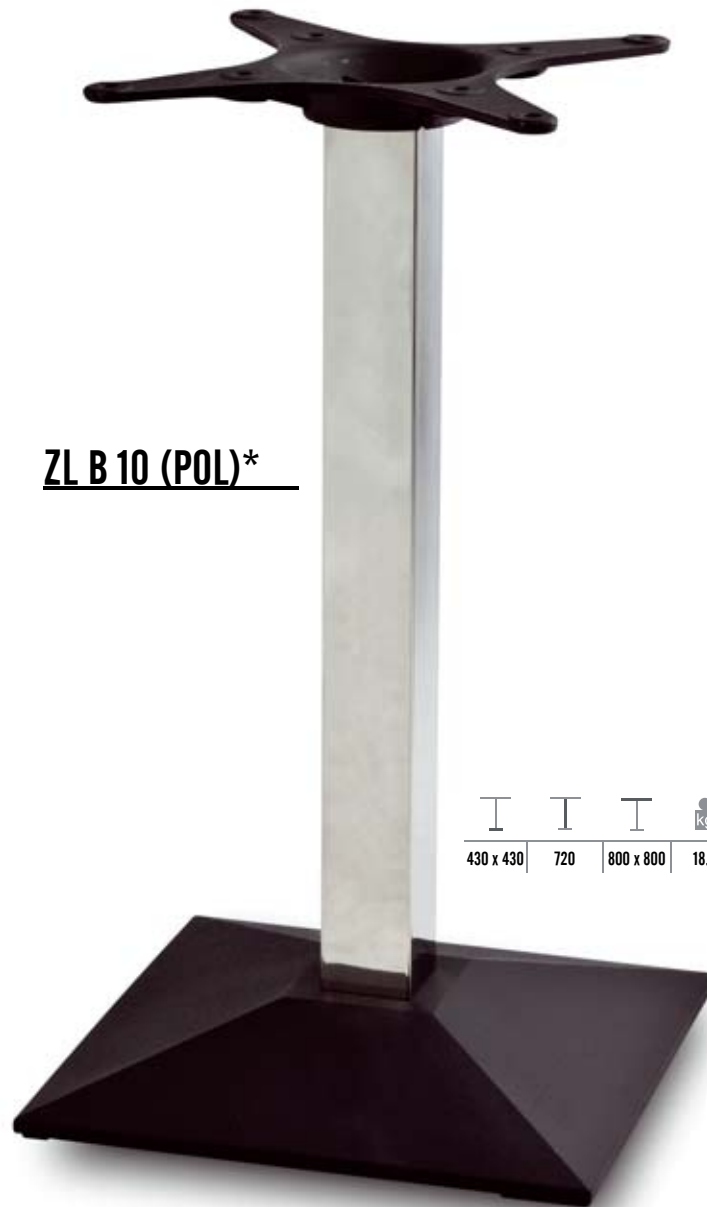

ZL B 10 (POL)*

430 x 430	720	800 x 800	18.0

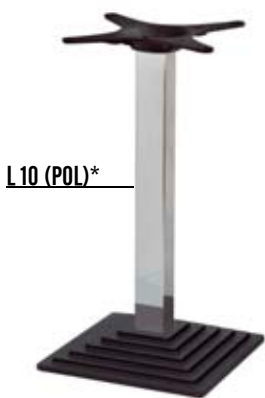

L 10 (POL)*

430 x 430	720	800 x 800	18.0



L BIG 10 (POL)*

560 x 560	720	1000 x 1000	28.0



GH 10 (POL)*

710 x 710	720	∅1100 1000 x 1000	21.5



ZL C 10 (POL)*

620 x 420	720	1200 x 800	25.0

cast iron base + stainless steel, polished column

Gusseisenbasis + Edelstahlstütze, poliert

CAST IRON + STEEL

GUSSEISEN – UND STAHLUNTERBAU

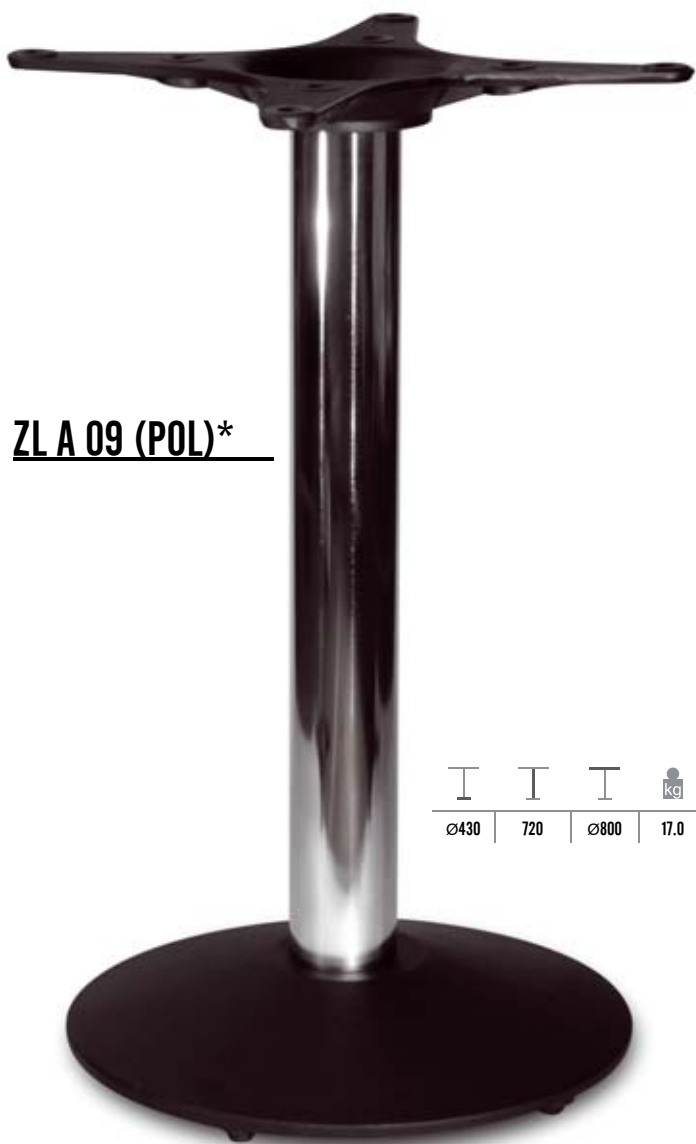

ZL A 09 (POL)*

Ø430	720	Ø800	17.0



GH 09 (POL)*

710 x 710	720	Ø1100 1000 x 1000	21.5

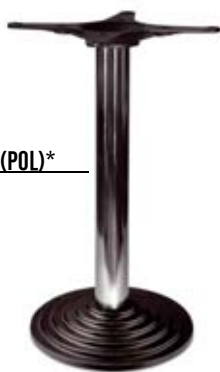

J 09 (POL)*

Ø430	720	Ø800	17.5

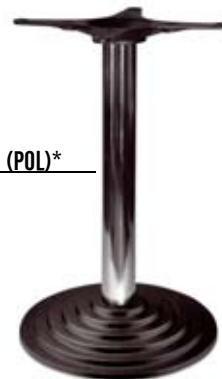

J BIG 09 (POL)*

Ø560	720	Ø1100	20.0

* model dostępny w wysokości COFFEE i BAR
model is available in COFFEE and BAR height / Modell verfügbar in der Höhe COFFEE und BAR

BIS 3R

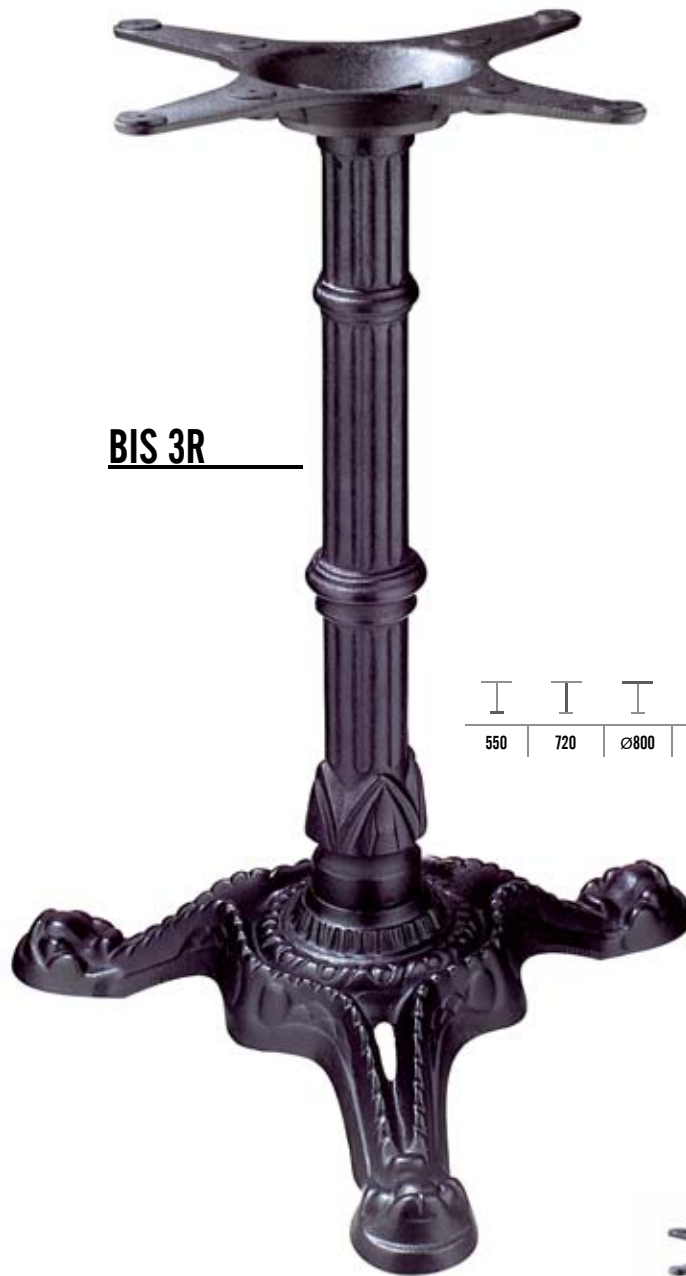

550	720	∅800	21.0

BIS 4R



450 x 450	720	800 x 800	23.0

BIS 4R BAR



450 x 450	1060	700 x 700	23.5

cast iron base + cast iron column
Gusseisenbasis + Gusseisenstütze

CAST IRON
GUSSEISENUNTERBAU

CONTI 4R



450 x 450	720	800 x 800	22.0

Conti 3R



520	720	∅800	16.5

Conti Rect



840 x 500	720	1200 x 800	27.0



FL C 02 (BK)*

600 x 405	720	1200 x 800	22.5



FL B BIG 02 BAR (BK)

555 x 555	1060	800 x 800	27.0



FL C DUET 02 (BK)*

740 x 485	600	1400 x 900	33.5

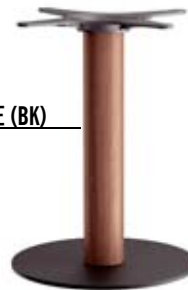

FL A 01 COFFEE (BK)

ø410	600	ø800	15.0



FL A BIG 01 BAR (BK)

ø570	1060	ø900	24.5

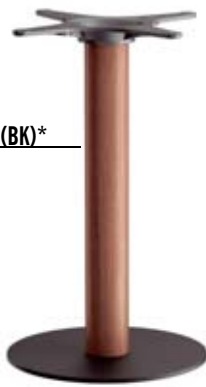

FL A 01 (BK)*

ø410	720	ø800	15.5

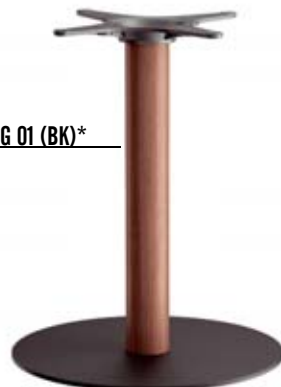

FL A BIG 01 (BK)*

ø570	720	ø1100	22.5



FL B 02 (BK)*

405 x 405	720	800 x 800	17.5



FL B BIG 02 (BK)*

555 x 555	720	1000 x 1000	26.0

powder painted steel base + wooden column (beech)

Stahlbasis + Buchenholzstütze

POWDER PAINTED STEEL

LACKIERTER (BK) STAHLUNTERBAU

FL C DUET 02 (ALU)*



740 x 485	720	1400 x 900	33.5

FL C 02 (ALU)*



600 x 405	720	1200 x 800	22.5

FL A 01 COFFEE (ALU)

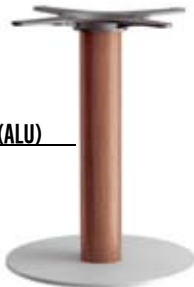

∅410	600	∅800	15.0

FL A 01 (ALU)*

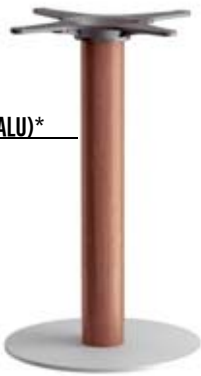

∅410	720	∅800	15.5

FL A BIG 01 (ALU)*

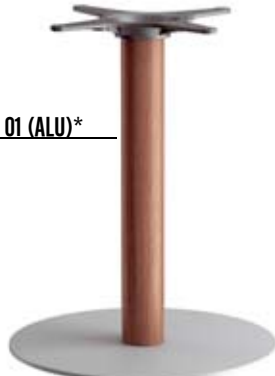

∅570	720	∅1100	22.5

FL B 02 (ALU)*



405 x 405	720	800 x 800	17.5

FL B BIG 02 (ALU)*



555 x 555	720	1000 x 1000	26.0

EKOLOGIJA

* model dostępny w wysokości COFFEE i BAR
model is available in COFFEE and BAR height / Modell verfügbar in der Höhe COFFEE und BAR



FL C DUET 10 (ALU)*



740 x 485	720	1400 x 900	32.5

FL B 10 (ALU)*



405 x 405	720	800 x 800	17.0

FL B BIG 10 (ALU)*



555 x 555	720	1000 x 1000	25.5

FL C DUET 10 BAR (ALU)

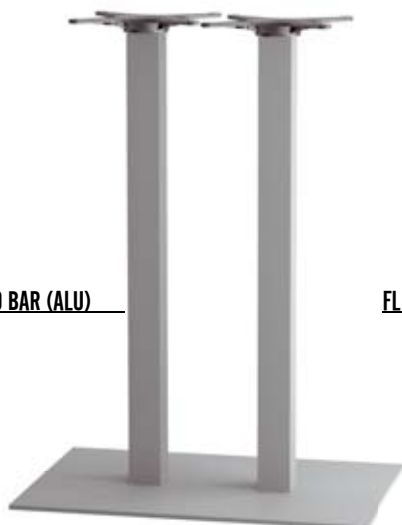

740 x 485	1060	1200 x 700	35.5

FL C 10 BAR (ALU)

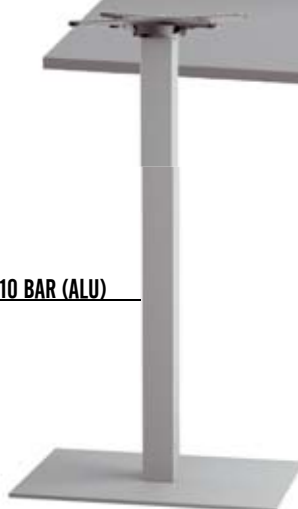

600 x 405	1060	1000 x 600	23.5

FL C 10 (ALU)*

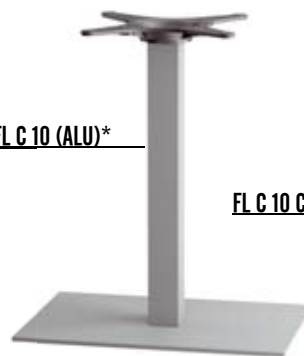

600 x 405	720	1200 x 800	22.0

FL C 10 COFFEE (ALU)



600 x 405	600	1200 x 800	21.0

powder painted steel base and column (aluminium colour)

Stahlbasis + Stahlstübe, Farbe Alu





POWDER PAINTED STEEL





LACKIERTER (ALU) UNTERBAU

FL A BIG 09 (ALU)*

FL B BIG 09 (ALU) *

FL C 09 (ALU)*

			
∅555	720	∅1100	22.5

			
555 x 555	720	1000 x 1000	25.5



			
600 x 405	720	1200 x 800	22.0

FL A 09 (ALU)*

FL A BIG 09 BAR (ALU)

FL A 09 COFFEE (ALU)

FL A 09 BAR (ALU)

			
∅405	720	∅800	15.0

			
∅555	1060	∅900	24.0

			
∅405	600	∅800	14.5

			
∅405	1060	∅700	16.5

* model dostępny w wysokości COFFEE i BAR
model is available in COFFEE and BAR height / Modell verfügbar in der Höhe COFFEE und BAR

FL C DUET 10 (BK)*

			
740 x 485	720	1400 x 900	32.5

FL C 10 (BK)*

			
600 x 405	720	1200 x 800	22.0

FL B 10 (BK)*

FL C DUET 10 BAR (BK)

FL B BIG 10 (BK)*

FL B 10 COFFEE (BK)

			
405 x 405	720	800 x 800	17.0

			
740 x 485	1060	1200 x 700	35.5

			
555 x 555	720	1000 x 1000	25.5

			
405 x 405	600	800 x 800	16.0

powder painted steel base and column (black colour)

Stahlbasis + Stahlstütze, Farbe schwarz

POWDER PAINTED STEEL

LACKIERTER (BK) STAHLUNTERBAU

FL C DUET 09 (BK)*

FL C 09 (BK)*

			
740 x 485	720	1400 x 900	32.5





			
600 x 405	720	1200 x 800	22.0





FL A 09 (BK)*

FL A BIG 09 (BK)*

FL A 09 COFFEE (BK)

FL A 09 BAR (BK)

			
Ø405	720	Ø800	15.0

			
Ø555	720	Ø1100	22.5

			
Ø405	600	Ø800	14.5

			
Ø405	1060	Ø700	16.5

* model dostępny w wysokości COFFEE i BAR
model is available in COFFEE and BAR height / Modell verfügbar in der Höhe COFFEE und BAR



FL B BIG 02 (POL)*

570 x 570	720	1000 x 1000	29.0 kg

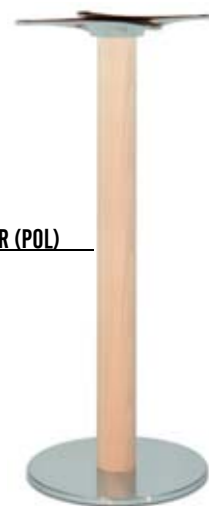

FL A 01 BAR (POL)

∅410	1060	∅700	17.5 kg

FL A BIG 01 (POL)*

∅570	720	∅1100	25.5 kg



FL A 01 COFFEE (POL)

∅410	600	∅800	16.0 kg

FL A 01 (POL)*

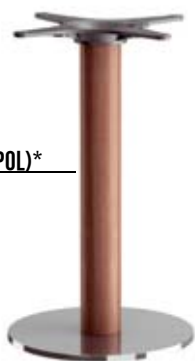

∅410	720	∅800	16.0 kg

FL C 02 (POL)*



615 x 420	720	1200 x 800	24.5 kg

FL B 02 (POL)*

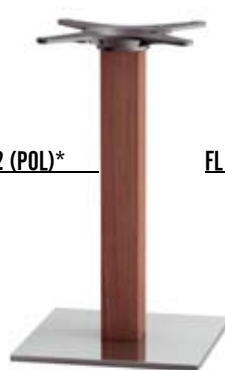

420 x 420	720	800 x 800	19.0 kg

FL C DUET 02 (POL)*



755 x 500	720	1400 x 900	36.0 kg

stainless steel, polished base + wooden column (beech)

Edelstahlbasis, poliert + Buchenholzstütze

POLISHED STAINLESS STEEL (POL)

UNTERBAU POLIERT (POL)

FL B BIG 01 BAR (POL)



570 x 570	1060	800 x 800	30.0

FL B 02 COFFEE (POL)



420 x 420	600	800 x 800	18.5

FL C DUET 02 BAR (POL)

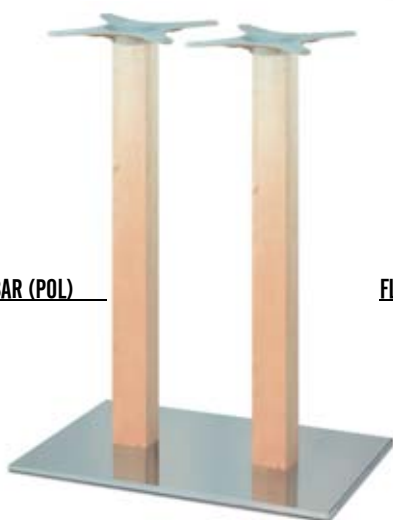

755 x 500	1060	1200 x 700	38.0

FL C 02 COFFEE (POL)



615 x 420	600	1200 x 800	24.0

FL C 01 BAR (POL)



615 x 420	1060	1000 x 600	25.5

* model dostępny w wysokości COFFEE i BAR
model is available in COFFEE and BAR height / Modell verfügbar in der Höhe COFFEE und BAR

FL C 09 COFFEE (POL)



615 x 420	600	1200 x 800	23.0

FL C DUET 09 (POL)*



755 x 500	720	1400 x 900	35.0

FL C DUET 10 BAR (POL)



755 x 500	720	1400 x 900	35.0

FL B 10 BAR (POL)



570 x 570	720	1000 x 1000	28.5

FL C DUET 10 BAR (POL)	755 x 500	1060	1200 x 700	38.0
FL B 10 BAR (POL)	420 x 420	1060	700 x 700	20.0

FL B BIG 10 (POL)*



FL C 09 (POL)*



615 x 420	720	1200 x 800	24.0

stainless steel, polished base and column

Basis + Edelstahlstütze, poliert

POLISHED STAINLESS STEEL (POL)

UNTERBAU POLIERT (POL)



FL B BIG 09 (POL)*



FL A BIG 09 (POL)*

720	570	1100	25.0

570 x 570	720	1000 x 1000	28.5

FL A 09 BAR (POL)



1060	720	410	17.5

FL A 09 COFFEE (POL)



800	600	410	15.0

FL A 09 (POL)*



720	720	410	16.0

FL C 10 (POL)*



1200 x 800	720	615 x 420	24.0

FL B 09 (POL)*



800 x 800	720	420 x 420	18.5

FL B 10 (POL)*

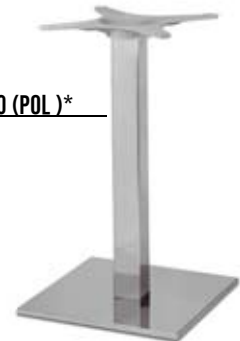

800 x 800	720	420 x 420	18.5

* model dostępny w wysokości COFFEE i BAR
model is available in COFFEE and BAR height / Modell verfügbar in der Höhe COFFEE und BAR

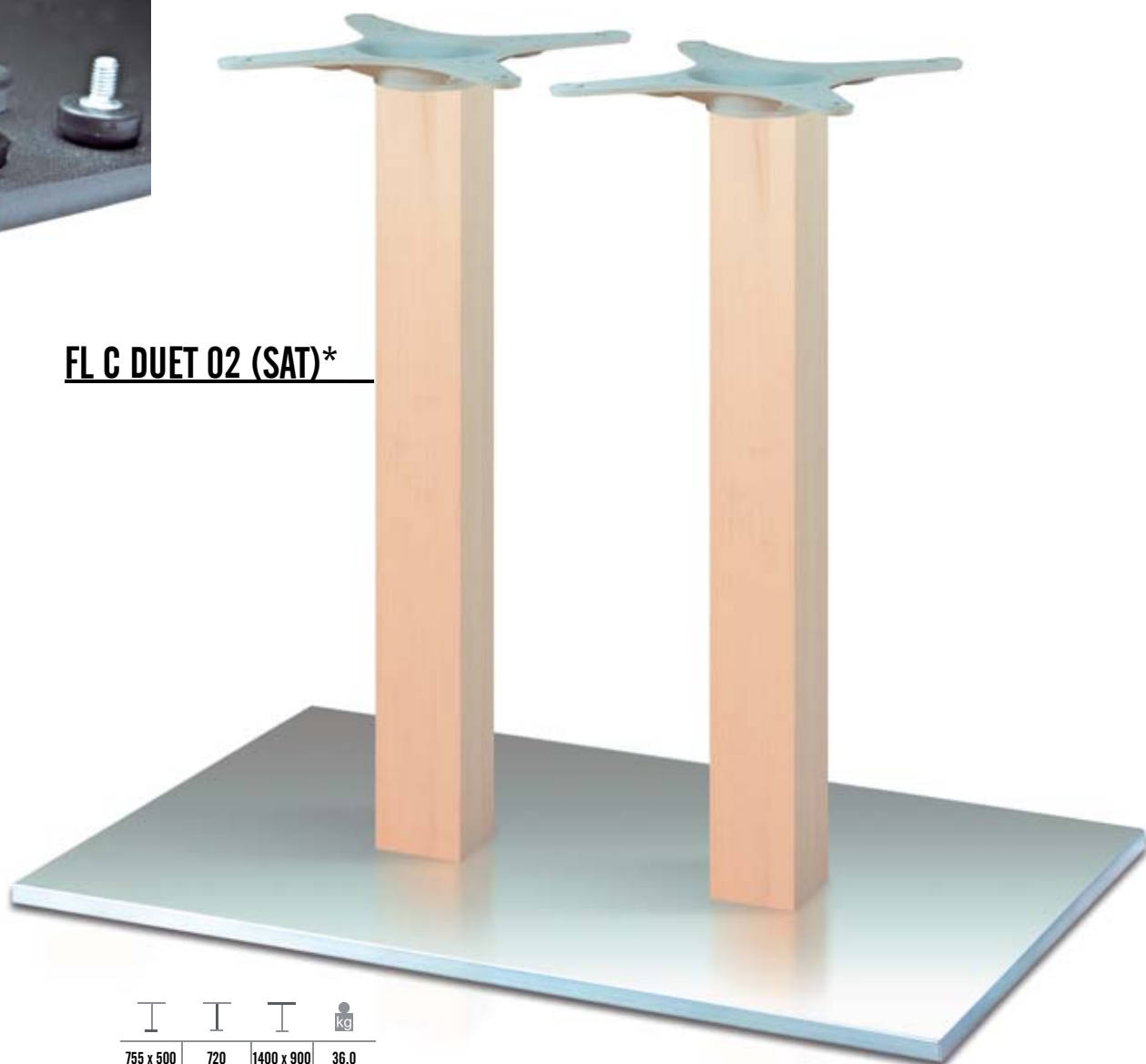

FL C DUET 02 (SAT)*

755 x 500	720	1400 x 900	36.0

FL B 02 (SAT)*



420 x 420	720	800 x 800	19.0

FL A BIG 01 (SAT)*

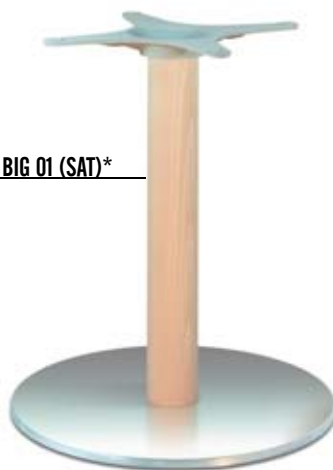

Ø570	720	Ø1100	25.5

FL C 02 (SAT)*

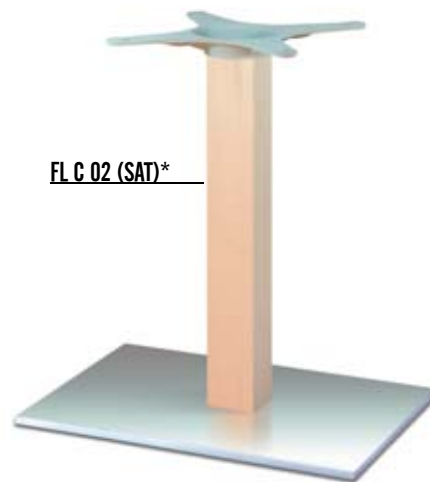

615 x 420	720	1200 x 800	24.5

stainless steel, brushed base + woodem column (beech)

Edelstahlbasis, gebürstet + Buchenholzstütze

SATINED STAINLESS STEEL (SAT)

SATINUNTERBAU (SAT)

FL A 01 (SAT)*



Ø410	720	Ø800	16.5

FL A 01 COFFEE (SAT)



Ø410	600	Ø800	15.5

FL B 02 COFFEE (SAT)



420 x 420	600	800 x 800	18.5

FL B BIG 02 (SAT)*

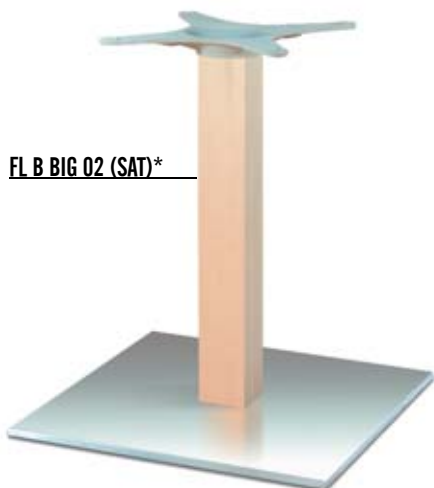

570 x 570	720	1000 x 1000	29.0

FL C DUET 01 BAR (SAT)

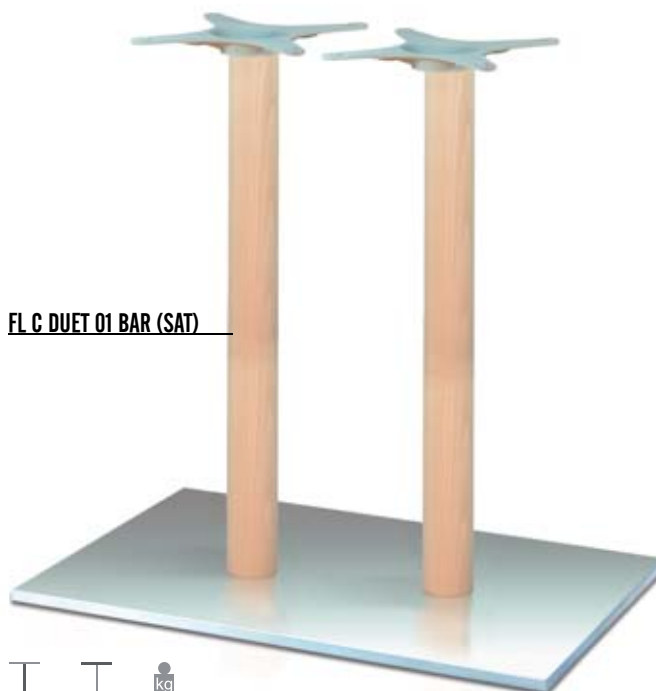

755 x 500	1060	1200 x 700	38.0

STABILNOŚĆ

* model dostępny w wysokości COFFEE i BAR
model is available in COFFEE and BAR height / Modell verfügbar in der Höhe COFFEE und BAR

FL C DUET 10 (SAT)*

FL C 10 (SAT)*

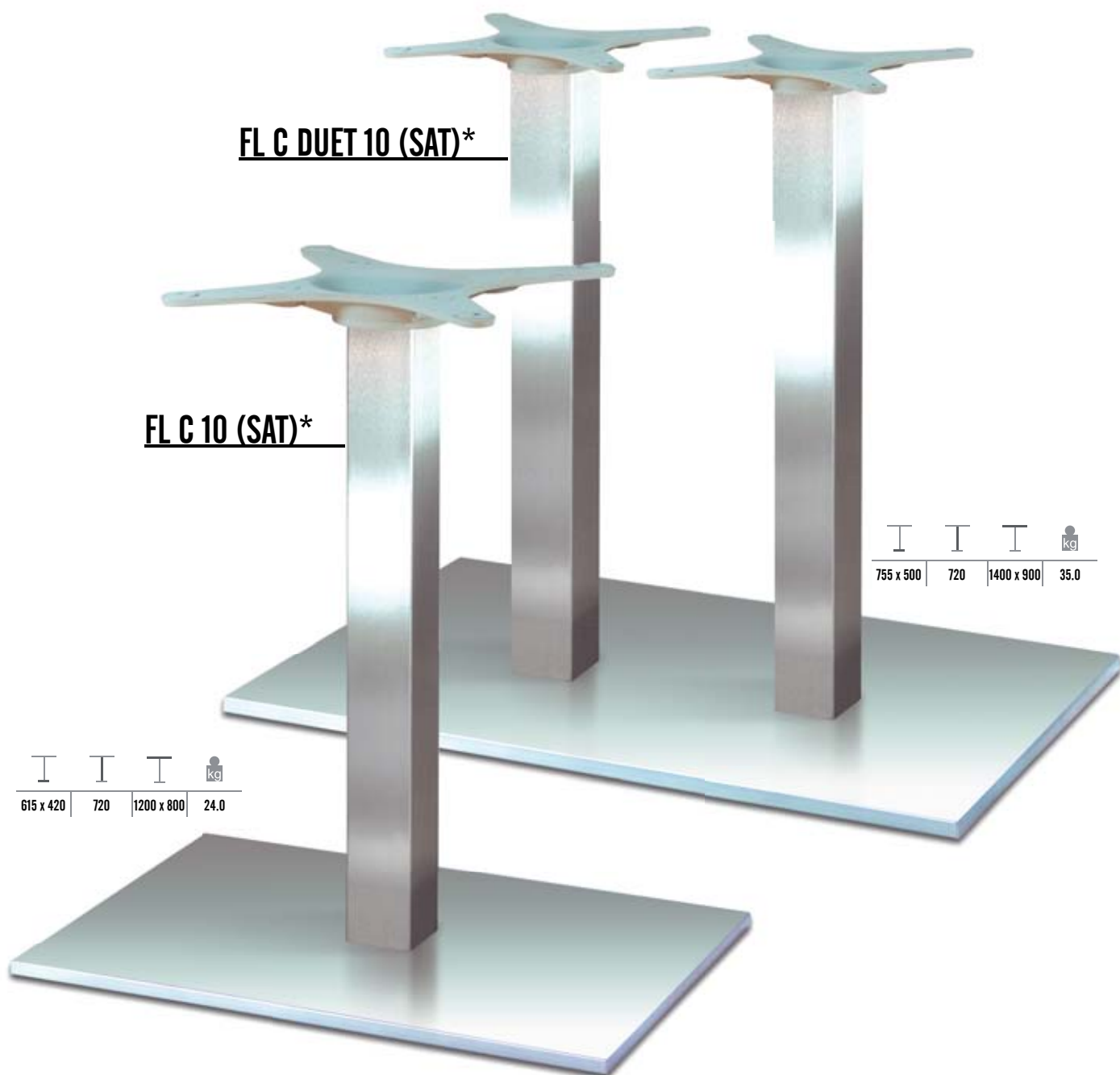

615 x 420	720	1200 x 800	24.0

755 x 500	720	1400 x 900	35.0

FL B BIG 10 (SAT)*

FL B 10 (SAT)*

FL B 10 COFFEE (SAT)

FL B 09 (SAT)*



570 x 570	720	1000 x 1000	28.5

420 x 420	720	800 x 800	18.5

420 x 420	600	800 x 800	17.5

420 x 420	720	800 x 800	18.5

stainless steel, brushed base and column

Edelstahlbasis und -stütze, gebürstet

SATINED STAINLESS STEEL (SAT)

SATINUNTERBAU (SAT)

FL C DUET 09 (SAT)*



755	x 500	720	1400 x 900
			35.0

FL A 09 (SAT)*

Ø410	720	Ø800	16.0

FL C 09 (SAT)*



615	x 420	720	1200 x 800
			24.0

FL B BIG 09 (SAT)*



570	x 570	720	1000 x 1000
			28.5

FL A BIG 09 (SAT)*



Ø570	720	Ø1100	25.0

FL A 09 COFFEE (SAT)



Ø410	600	Ø800	15.0

* model dostępny w wysokości COFFEE i BAR
model is available in COFFEE and BAR height / Modell verfügbar in der Höhe COFFEE und BAR

STOŁY Z BLATAMI SZKLANYMI podstawa ze stali lakierowanej lub nierdzewnej, blaty ze szkła „bezpiecznego”



STS/A (SAT)*

∅410	720	∅600	19.0



STS/A (BK)*

∅405	720	∅600	18.0



STS/A (ALU)*

∅405	720	∅600	18.0



STS/A (POL)*

∅410	720	∅600	19.0

powder painted or stainless steel base + safety glass table top

Unterbau aus lackiertem Stahl oder Edelstahl, Tischblatt - „Sicherheitsglas“

GLASS TOP TABLES

TISCHE MIT GLASBLATT



STS/B (ALU)*



I	I	I	kg
405 x 405	720	600 x 600	20.0



STS/ B (BK)*

I	I	I	kg
405 x 405	720	600 x 600	20.0



STS/B (POL)*

I	I	I	kg
410 x 410	720	600 x 600	21.0



STS/B (SAT)*

I	I	I	kg
410 x 410	720	600 x 600	21.0

* model dostępny w wysokości COFFEE i BAR
model is available in COFFEE and BAR height / Modell verfügbar in der Höhe COFFEE und BAR



FIX / BAR / SUPP (POL)

I	I	I	kg
Ø200	1060	Ø800	11.0

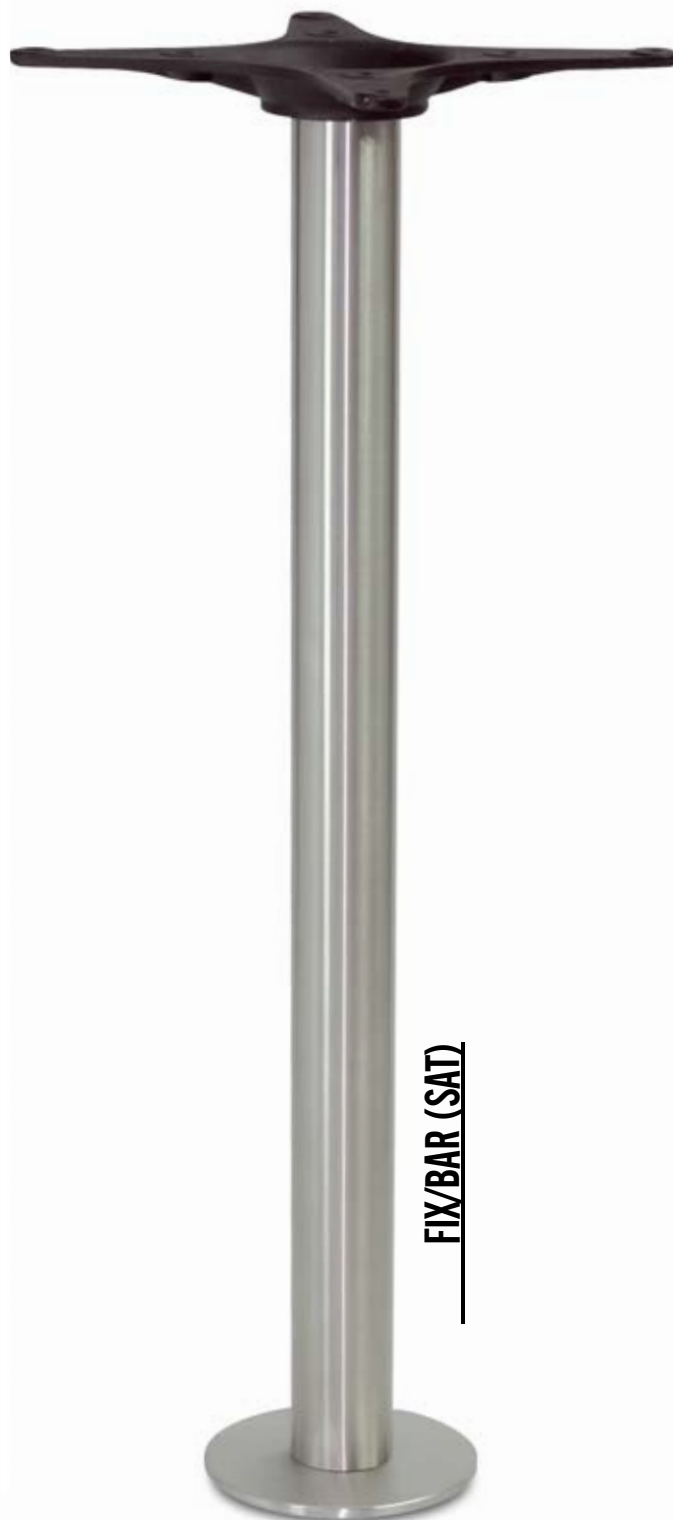

FIX / BAR (SAT)

I	I	I	kg
Ø200	1060	Ø800	9.0

powder painted or stainless steel base and column

Basis + Stütze aus lackiertem Stahl oder Edelstahl

FIXED TABLE BASES

AN FUßBODEN ANGESCHRAUBTER UNTERBAU (FIX)



FIX/BAR/SUPP (ALU)



FIX/BAR (ALU)

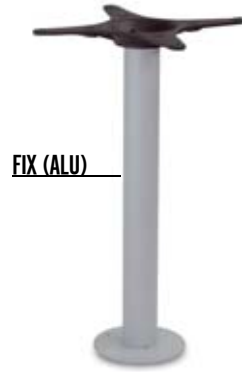

FIX (ALU)



FIX/BAR/SUPP (BK)



FIX/BAR (BK)



FIX (BK)



FIX/BAR/SUPP (SAT)



FIX/BAR (POL)



FIX (SAT)

FIX (POL)

∅200	1060	∅800	kg
			11.0

∅200	1060	∅800	kg
			9.00

∅200	720	∅800	kg
			8.0

KAWIARNIJA

STELAŻE DO HOKERÓW I FOTELI

BARSTOOL AND ARMCHAIR BASES

HOCKER UND SESSEL GESTELL

baza + kolumna ze stali lakierowanej lub nierdzewnej

powder painted or stainless steel base and column

Basis + Stütze aus lackiertem Stahl oder Edelstahl



HOK (ALU)*

765	Ø405	11.0 kg



HOK/SUPP (ALU)*

765	Ø405	12.0 kg



FOT (POL)*

345	Ø410	11.0 kg



HOK (SAT)*

765	Ø410	11.5 kg



HOK/SUPP (BK)*

765	Ø405	12.0 kg



FOT (SAT)*

345	Ø410	11.0 kg

baza + kolumna stalowa, lakierowana, kolor czarny (wersja ekonomiczna)

Powder painted steel base and column (black colour, economic version)





Basis + Stahlstütze, lackiert, Farbe schwarz (sparsame Version)

PODSTAWY LAKIEROWANE (EKO)

POWDER PAINTED STEEL (EKO)





UNERBAU, LACKIERT (EKO)

EKO C**

			
600 x 405	720	1100 x 700	18.0

****EKO B**

EKO A**

			
405 x 405	720	700 x 700	14.0

			
Ø405	720	Ø700	12.0

** model dostępny tylko w wykończeniu BK i wysokości STANDARD / model is available in BK finish and STANDARD height only / model verfügbar in der Ausführung BK und der Höhe STANDARD

